

The Case for the Aft Weather Cover Over *Titanic's* Aft First Class Staircase Having Two Sidelights on Its Aft Face

By Bob Read, D.M.D.

Introduction

This article will present the case for the aft weather cover over *Titanic's* aft first class staircase having two sidelights on its aft face. This will be done by comparing the configuration of *Titanic's* weather cover over both fore and aft first class staircases with those of her sister ship *Olympic*. The function of the weather covers of both ships will be examined. After these aspects are examined, an analysis will be done to determine if a case can be made for the configuration of the aft face of the aft staircase weather cover.

Preliminary Considerations

For many years, the aft weather cover over *Titanic's* aft first class staircase has been portrayed as having no sidelights. Recently I asked a number of *Titanic* researchers and authorities if they knew of any direct evidence which would support this configuration. Nobody knew of any. At this point I knew that commonly accepted portrayals of the aft weather cover were suspect. Since we have no direct evidence, we must look at indirect evidence which will support any particular configuration. One aspect of indirect evidence which will be examined is how *Titanic's* aft weather cover compares to *Olympic's*. Additionally, the function of both skylights and how they compare will be examined. Finally, a determination will be made whether indirect evidence will support any particular configuration.

Configuration of *Olympic's* Weather Covers

Figure 1 shows the configuration of *Olympic's* weather covers over the forward and aft first class staircases. On the forward weather cover the sidelights are hinged for opening like portholes. Additionally, each silight had a hinged shutter which could cover the silight.

Go to next page

Olympic

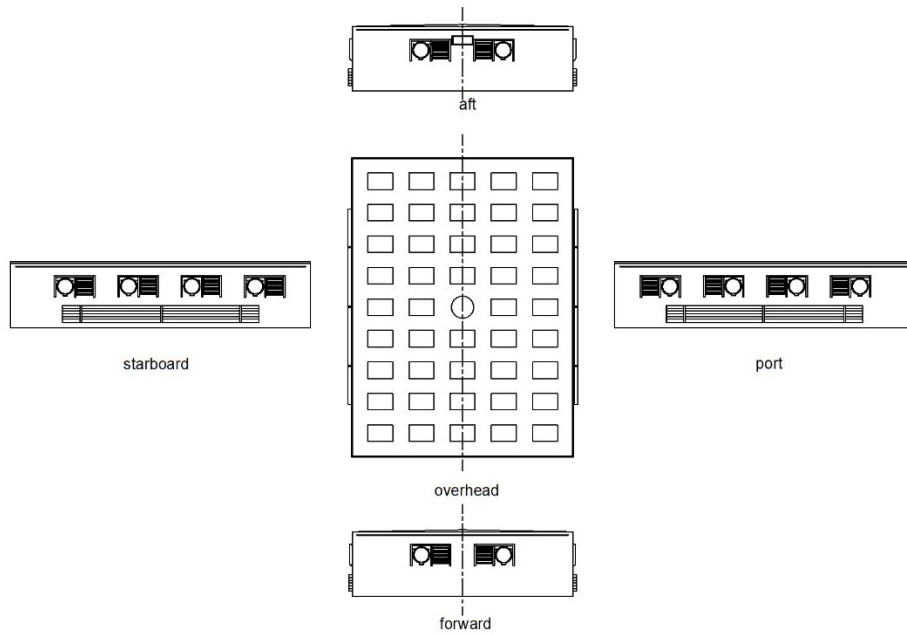

weather cover over forward 1st class staircase

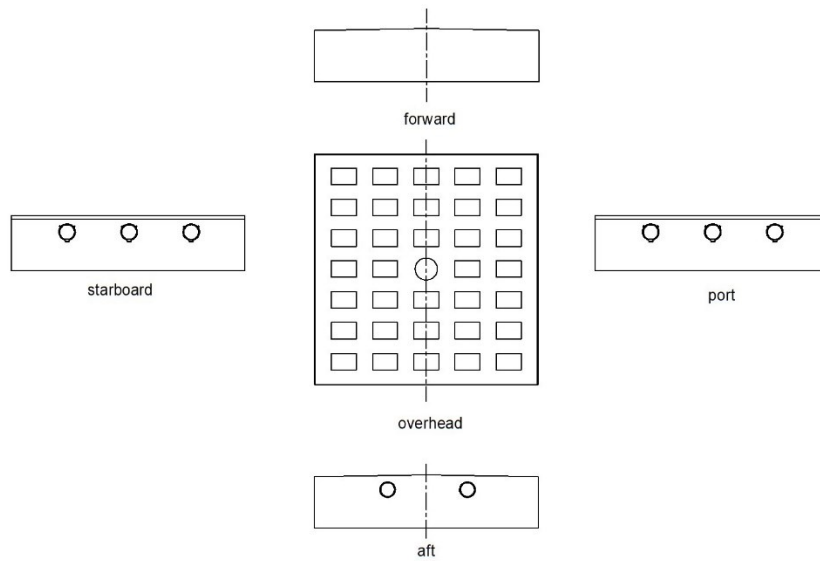

weather cover over aft 1st class staircase

Figure 1

Olympic's forward and aft first class stairway weather covers

Figure 2 shows *Titanic's* forward and aft first class stairway weather covers. The proposed configuration is outlined in red.

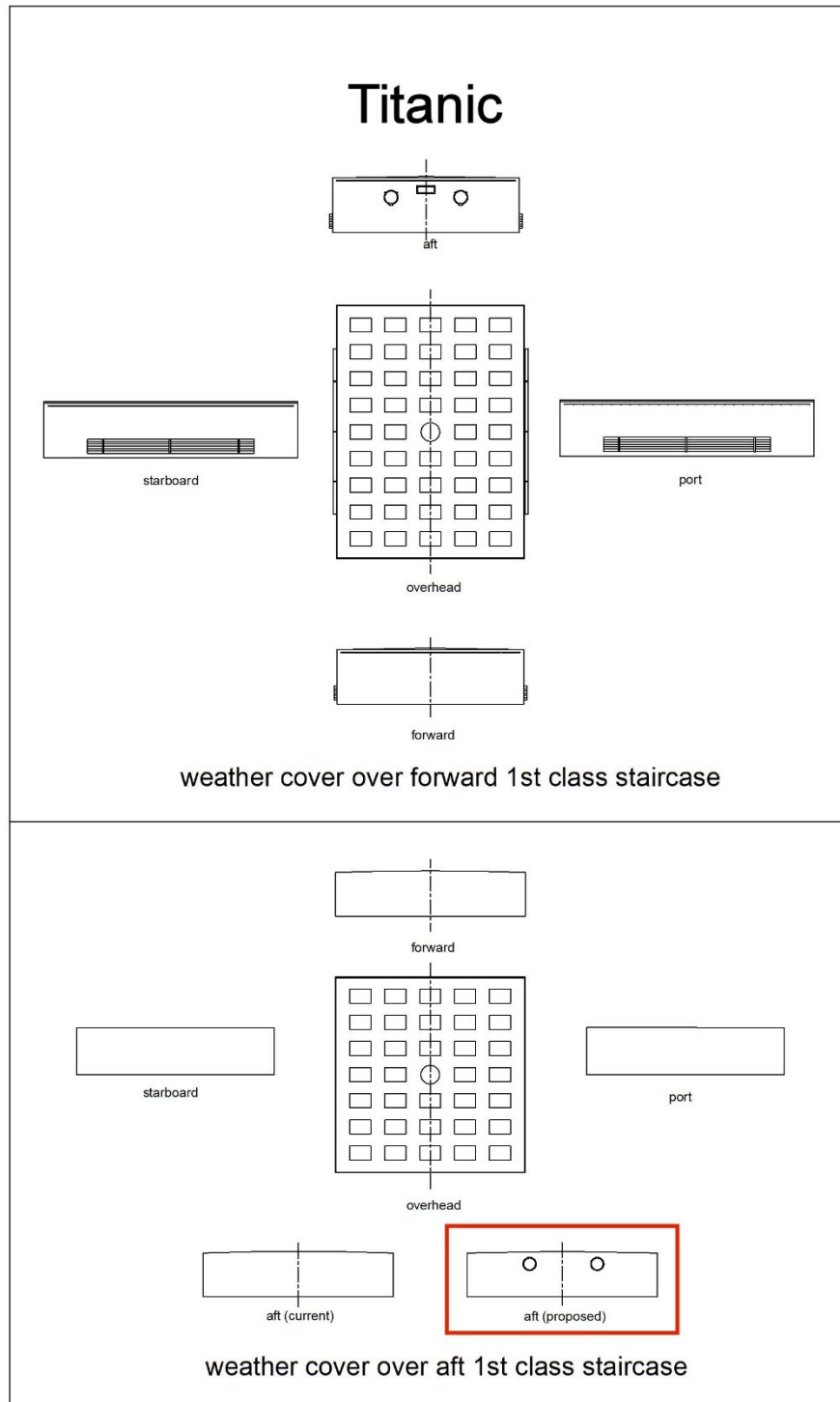

Figure 2

Titanic's forward and aft first class stairway weather covers

There is no dispute about the configurations shown in Figures 1 and 2. We have ample photo evidence except for the aft face of Titanic's weather cover over its aft first class staircase.

Function

On *Olympic's* forward weather cover, air can enter any of the 12 sidelights. The air exhausts from the weather cover through a duct on the aft face which connects to the stokehold vent forward of funnel #2. Additionally, on *Olympic's* forward weather cover there were hinged shutters which could be closed over the sidelights to keep almost all light from entering the sidelights. Figure 3 shows plan and elevation views show the movement of air under the weather covers.

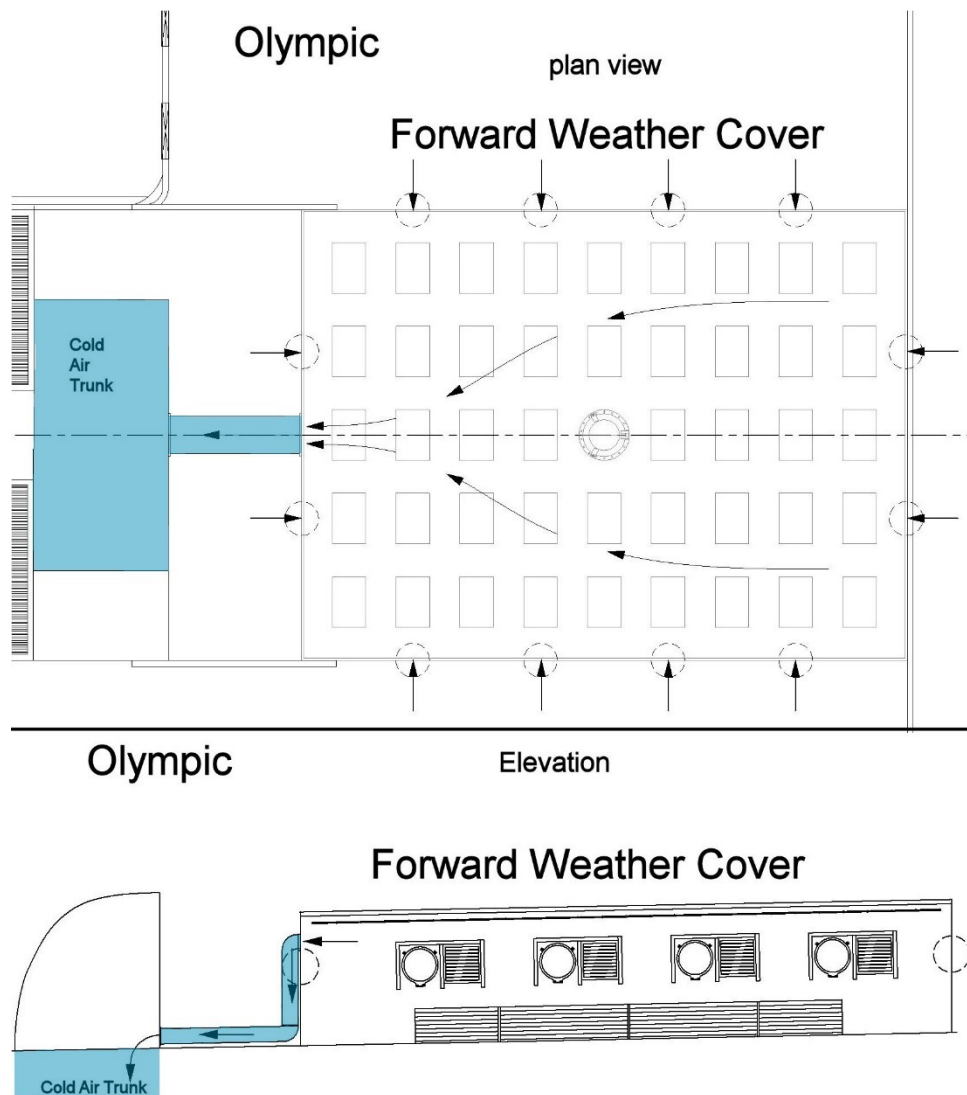

Figure 3

Flow of air in and out of *Olympic's* forward weather cover

Figure 4 shows plan and elevation views of air flow through *Olympic's* aft weather cover.

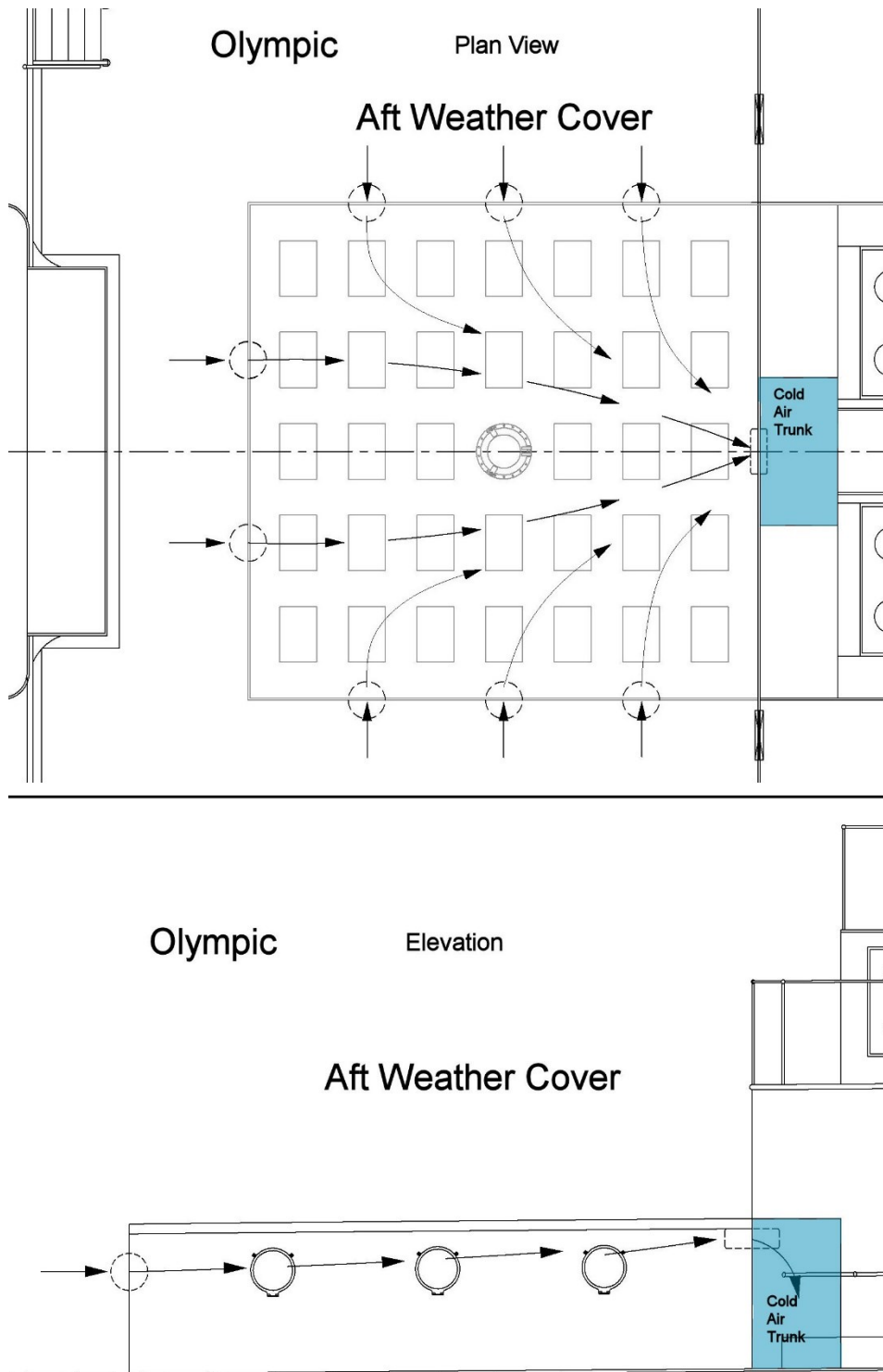

Figure 4

Flow of air in and out of *Olympic's* aft weather cover

Figure 5 shows the flow of air in and out of Titanic's forward weather cover.

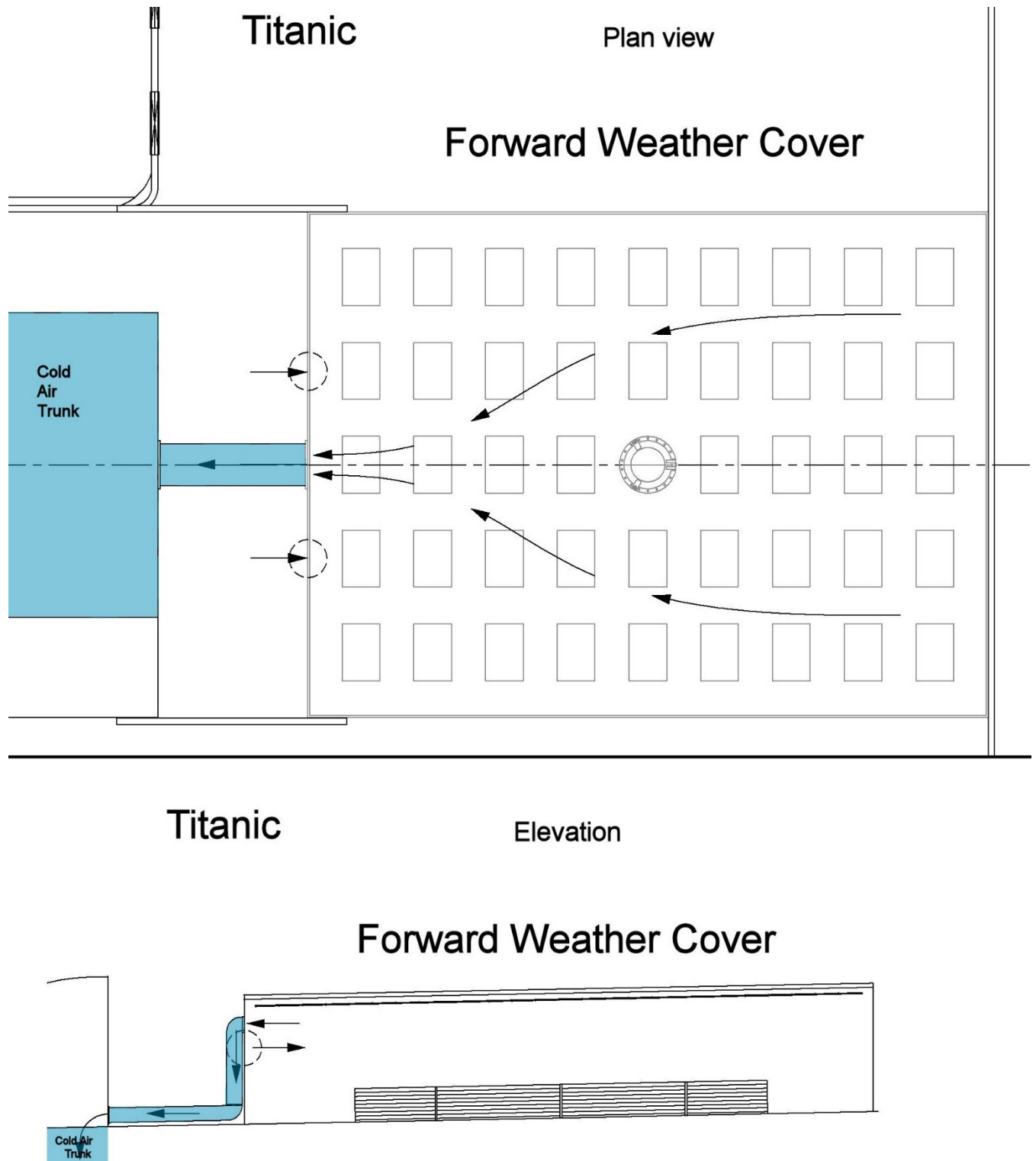

Figure 6

Flow of air in and out of *Titanic's* forward weather cover

Figure 7 shows the flow of air in and out of Titanic's aft weather cover.

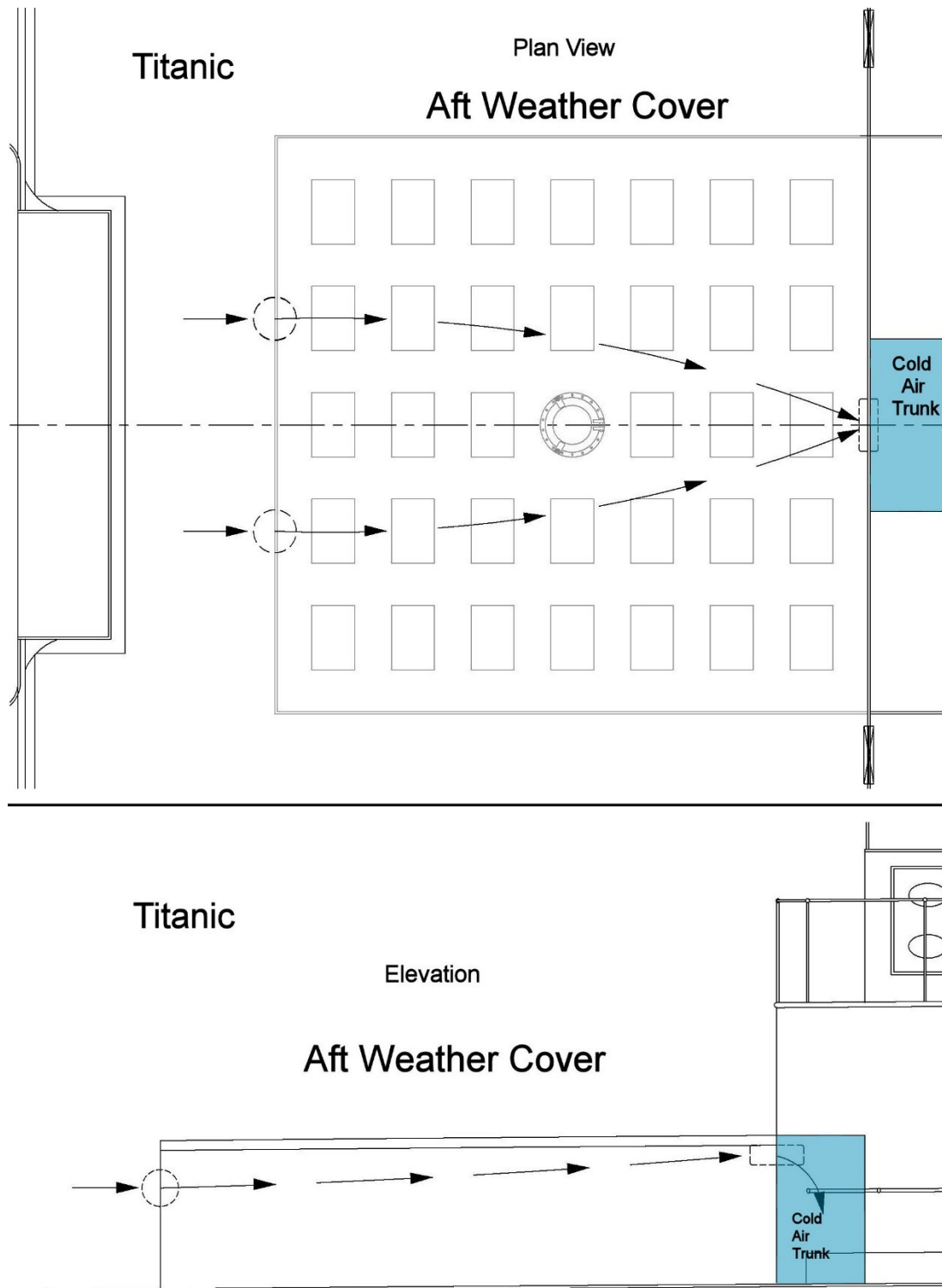

Figure 7

Flow of air in and out of Titanic's aft weather cover

Analysis

The differences between *Titanic* and *Olympic's* weather covers over their forward and aft first class staircases will be analyzed by answering a series of questions.

1. Why did the weather covers need sidelights?

The weather covers acted like greenhouses. With all sidelights closed, the air inside the weather covers would heat up. With the correct temperature and humidity, condensation could form inside the weather cover. To prevent this, the sidelights were opened to allow air to circulate and the temperature to equalize.

2. How was air circulation accomplished inside the weather covers?

To effect air circulation inside the weather covers, first the sidelights were opened. The movement of air was accomplished by natural draft assisted by electric fan ventilation below decks. The weather covers had ducts which connected with cold air trunks. Fans at the bottom of the trunks caused air inside the weather covers to move in through the sidelights then through the inside of the weather cover then out the weather cover duct into the cold air trunk.

3. Why were *Titanic* and *Olympic's* weather covers different?

The primary differences had to do with the number of sidelights. *Olympic's* weather covers had considerably more sidelights. It was likely found early during *Olympic's* first year in service that the time spent tending to its numerous sidelights was unnecessary. It was likely found that two sidelights per weather cover were sufficient to establish adequate airflow through the interior of the weather covers.

4. Why does the indirect evidence suggest two sidelights on the aft face of *Titanic's* aft weather cover over the first class staircases?

The weather covers required sidelights as a path for the intake of air into the interior of the weather covers. From there the air was exhausted out the duct into the cold air trunk. Without any sidelights, there would be no means to draw air into the weather cover to establish circulation.

5. Why would the sidelights on each weather cover of *Titanic* be located on their aft faces?

This is somewhat speculative but with the sidelights on the aft faces of the weather covers, it would be less likely for moisture to be drawn into the weather covers. If the sidelights were on the forward face, the prevailing wind created by the forward movement of the ship would tend to push moisture into an open sidelight on the forward face during inclement weather. Sidelights on port and starboard could have moisture forced into them with a wind coming from abeam. Sidelights located on the aft face would be the least likely direction for wind flow because it would be overcome

in all but the most extreme conditions by the wind coming from forward caused by the movement of the ship.

6. How would it be determined when to open the sidelights?

A crewman would be assigned to monitor the conditions inside the weather covers by observing the sidelights which had clear glass. If there was condensation on the inside of the glass, the sidelights would be opened. Usually by dusk the sidelights could again be closed. The conditions which would form condensation inside the weather covers would not be a daily occurrence. Certain times of the year and certain weather conditions would be favorable for forming condensation. As long as there was no condensation, the sidelights would remain closed.

Conclusion

With no direct evidence about the presence or absence of sidelights on the aft face of *Titanic's* aft weather cover over the first class stairway, we must look at indirect evidence to see if it supports sidelights there or not. After examining the indirect evidence, it appears clear that *Titanic* would have needed aft sidelights to establish air circulation under the weather cover. There appears to be no evidence which supports the absence of sidelights on the aft face of the aft weather cover. Figure 8 show the configuration of the aft face of *Titanic's* aft weather cover over the first class staircase which has the most evidence supporting it albeit indirect evidence.

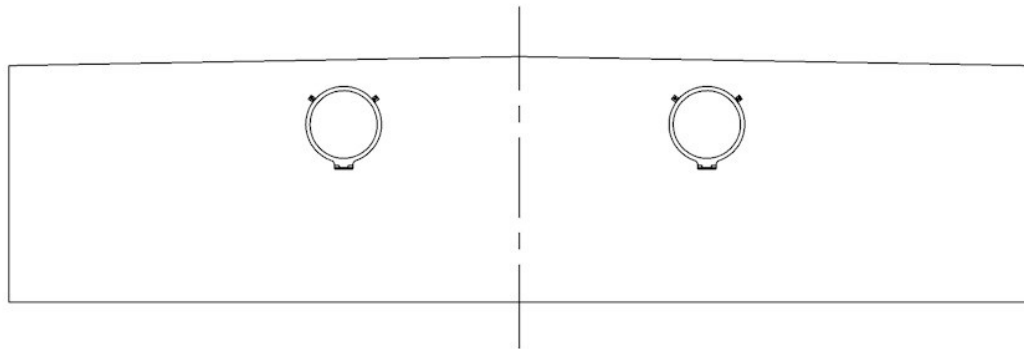

Figure 8

Proposed configuration of the aft face of *Titanic's* weather cover over the aft first class staircase.