

# A New Understanding of the Positions of the Welin Boat Davits Aboard Olympic and Titanic

## Introduction

During research with Ralph Currell into another area on Titanic which peripherally involved the Welin boat davits, Ralph noticed that the davits might not be positioned as originally thought. In the original positioning of the davits there were no detailed installation plans. Our assumption was that the davits were equally spaced on 33 ft. centers. Each davit was thought to be centered over a deck beam in order to maximize weight bearing strength under each davit. Further research has proven that assumption to be wrong.

In this article I will discuss the findings of the new research in some detail. This article is not intended to be an exhaustive examination and explanation of the methods and guidelines for the attachment of the davits to the underlying deck structures. References for this narrow subject have not been found. The focus of this article will be to show the fore and aft positioning of the davits for the benefit of the modeler, researcher, or historian.

The credit for the original discovery of this change in our understanding of the location of the davits goes to Ralph Currell. This discovery had to be fully explained before Ralph and I could complete our research in another area. After Ralph's initial discovery, this subject became a collaborative research effort to flesh out the details. There was a lot of discussion but finally the puzzle was solved. While Ralph and I both worked on this problem, I am not necessarily speaking for Ralph in all aspects. I am only presenting my understanding of our research.

In the explanation of the new davit positions, I will be using photos, drawings, and original Harland and Wolff plans to better illustrate the davit positions. The photos were crucial in explaining several key davit locations. The plans helped us formulate important "rules" which would guide us where there were no photos. Scale drawings allowed us to test and refine early hypotheses about the placement of the davits. It must be noted that these davit positions apply to Olympic's original double acting davits which were retained until her post-WWI refit. They also apply to Titanic's davits. They do not apply to Britannic's midship davits.

## Twin Carling Davit Locations

The term “carling” is used in shipbuilding to describe a short longitudinal deck beam used between transverse deck beams. In Fig. 1 we see a photo taken from Olympic’s promenade deck looking up at the underside of the boat deck.

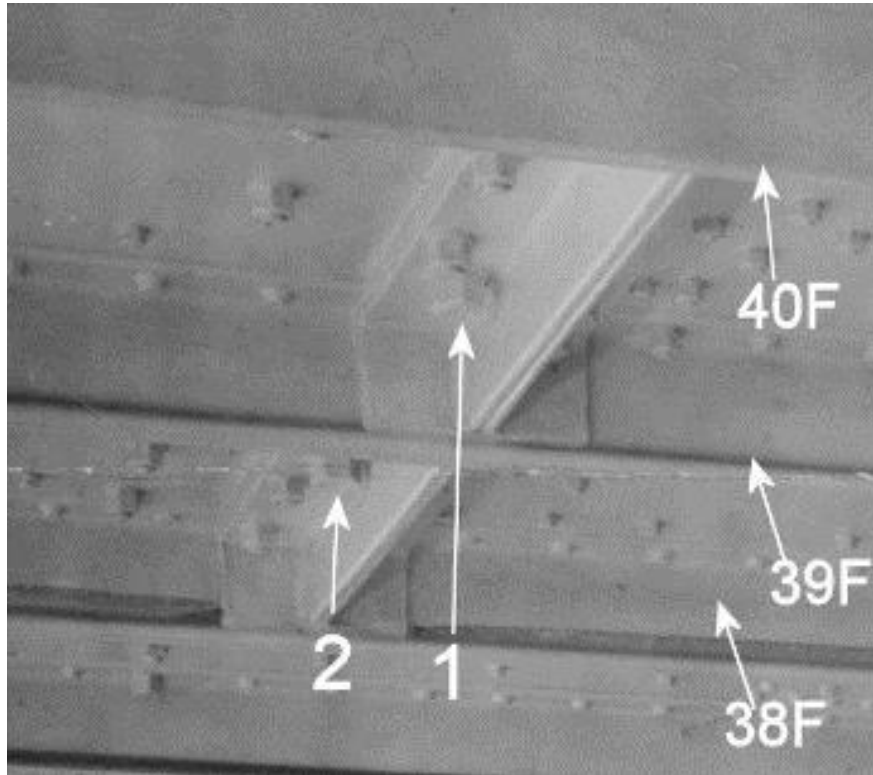

Figure 1

The carlings flank the deck beam at frame location 39F. These carlings are simple angle iron. They are doubled to form a “T” cross section and are joined by brackets to the transverse bulb angle deck beams.

Fig. 2 shows this area of the Harland and Wolff original Boat Deck Iron plan where the carlings flanking the deck beam 39F are added to the plan in pencil.

In Fig. 1 there are only two large davit bolts and nuts visible which are labeled “1” and “2”. This area is under the inboard end of the boat davit. The other smaller bolts visible are for the boat bitts, fairlead, and water hydrant. For the sake of simplicity these will not be labeled. The two bolts and nuts visible are on the outboard side of the carlings. They are bolts which pass through the outboard row of holes in the inboard foot of the twin frame davit base. The bolts

through the inboard row of holes in the inboard foot of the davit frame are not visible because they are obscured by the vertical aspect of the carling.

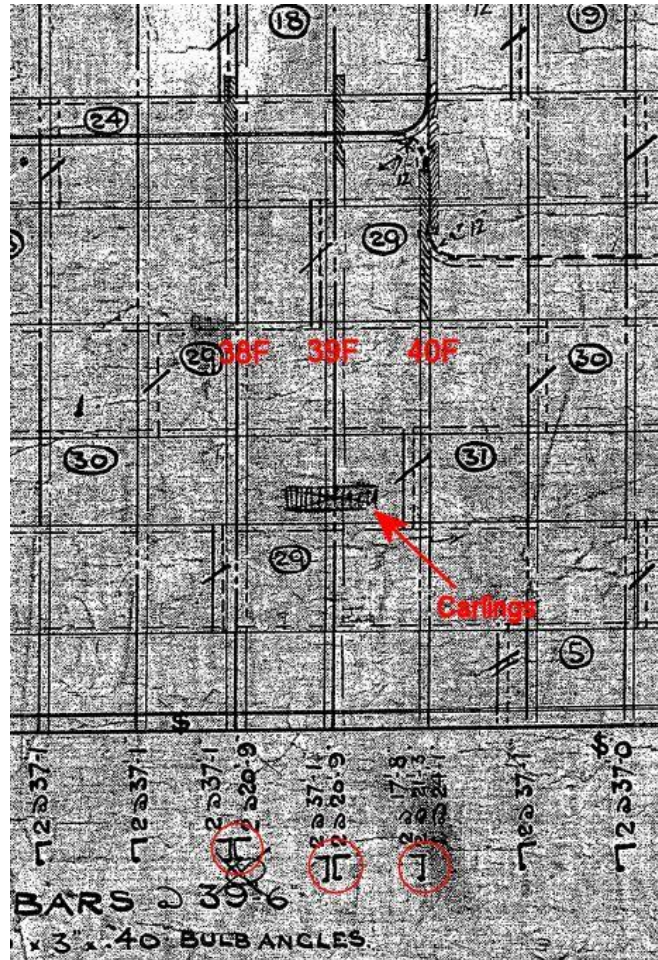

Figure 2

Figure 3 shows a drawing of the area. The bolts 1 and 2 shown in Fig. 1 are indicated in this drawing. The locations of other bolts which pass through the carling and deck beam are shown. It must be remembered that not every hole in the davit foot was used. This has been confirmed by photos.

In this drawing we can see that the davit is positioned aft of the center of beam 39F which is where it was originally thought to be centered. The drawing was produced in AutoCad so we are able to measure distances with precision. Additionally we have accurate dimensional plans of the davit frames and dimensions of the deck beams. With this information we are able to determine the fore and aft location of the davit frame with a high degree of precision. Using all

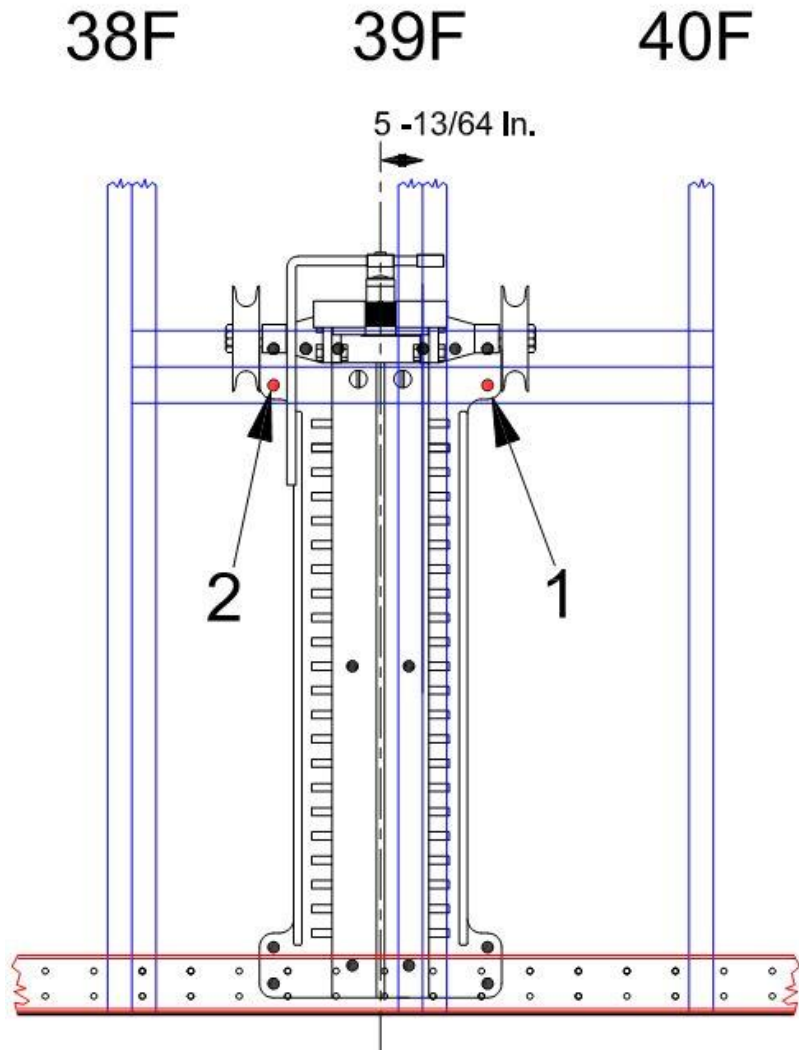

Figure 3

this information, I believe the davit frame was shifted 5 – 13/64 in. aft of beam 39F. The reason that a fraction of an inch in 64ths is given is because of the thickness of the vertical aspect of the bulb angle beam must be compensated for in centering bolt holes on the horizontal beam face.

The arrangement of carlings and davit in the area of 39F is representative of the arrangement found at most of the davit locations. The arrangement at other locations will be explained but the explanations will be abbreviated since the placement of the davit at 39F has been presented in detail.

## Single Carling Locations

There are three locations at which there is only one carling. Two of these are under the most forward and most aft davits which are both single frame davits. The third davit which has a single carling under it is the twin frame davit near frame 61F. This particular davit location is unique and will be discussed separately.

In Fig. 4 we are aft on Olympic's promenade deck looking up at the underside of the boat deck.

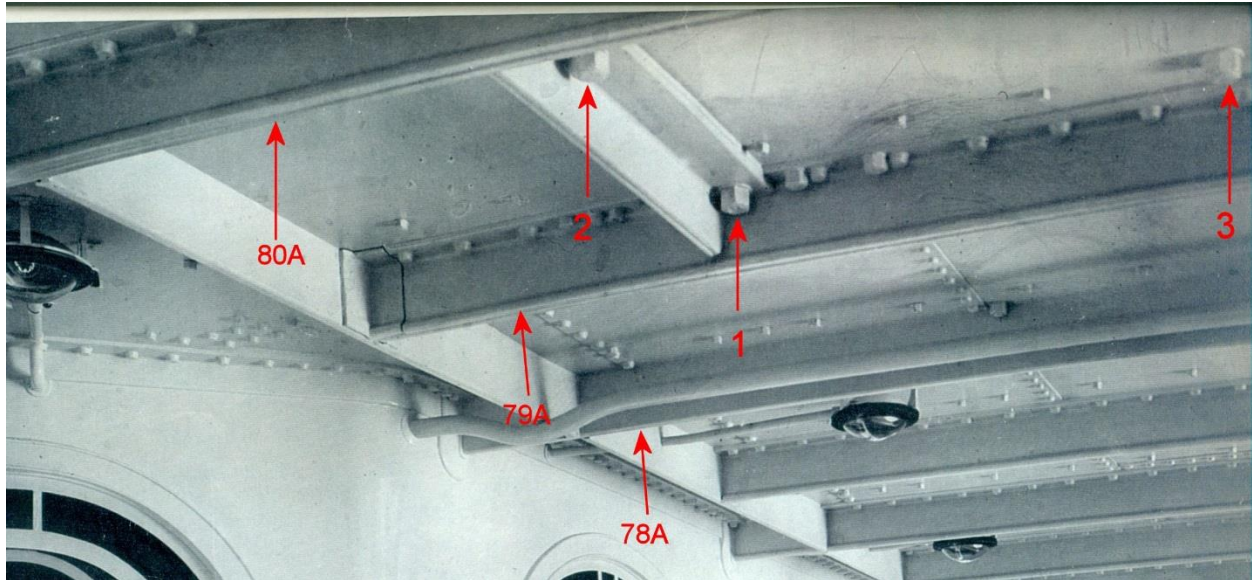

Figure 4

The beam locations and davit bolts and nuts are labeled in the photo. Fig. 5 shows this location on the Boat Deck Iron plan where the single carling is located aft of the deck beam at 79A. Fig. 6 is a drawing showing how the single frame davit was positioned in relation to beam 79A. The center of the davit was shifted aft of frame 79A by 13-37/64 in.

The most forward single frame davit located near the deck beam at frame 72F has the same arrangement as the one at 79A except that the carling is located forward of the beam at 72F. The center of this single davit frame is shifted 13-37/64 in. forward of the beam at 72F.

The only other davit with a single carling under it is the twin frame davit near the beam at 61F. Figs. 7, 8, & 9 show this single carling set-up in a photo, in the Boat Deck Iron plan, and in a drawing. The davit is shifted 14-61/64 in. forward of the deck beam at 61F. I can't give any readily apparent reason why this particular davit was set up over a single carling. I have some ideas but at this point I am hesitant to speculate as it serves no real purpose here.

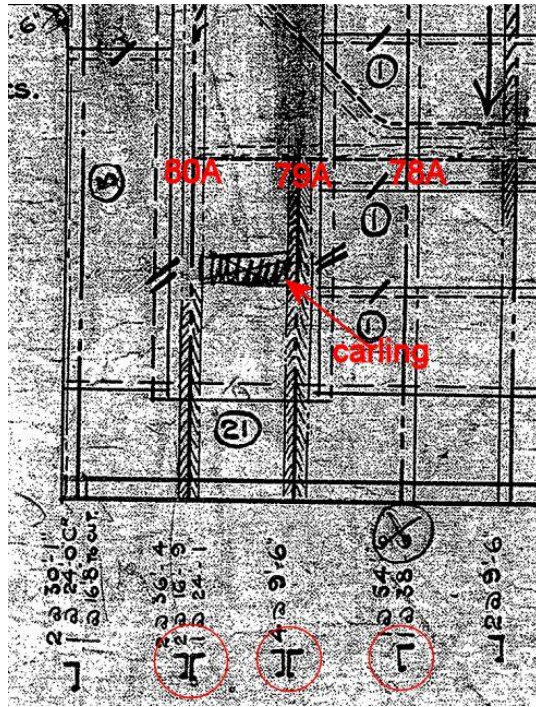

Figure 5

80A      79A      78A

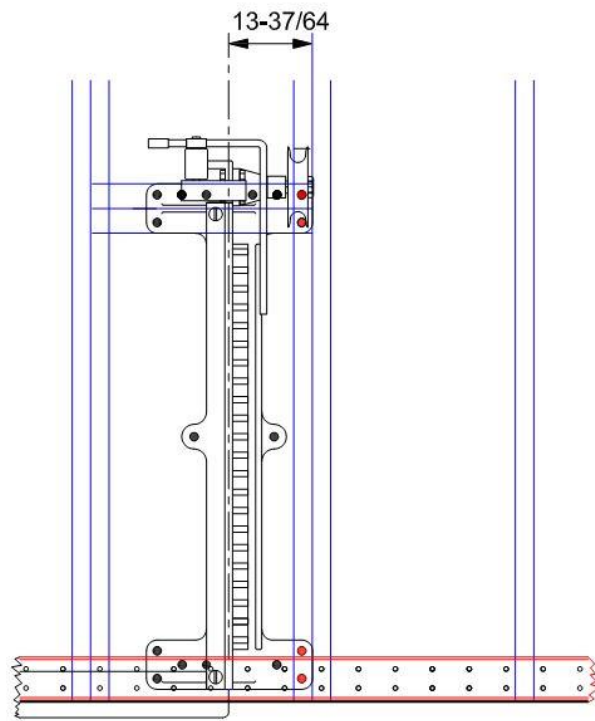

Figure 6



Figure 7

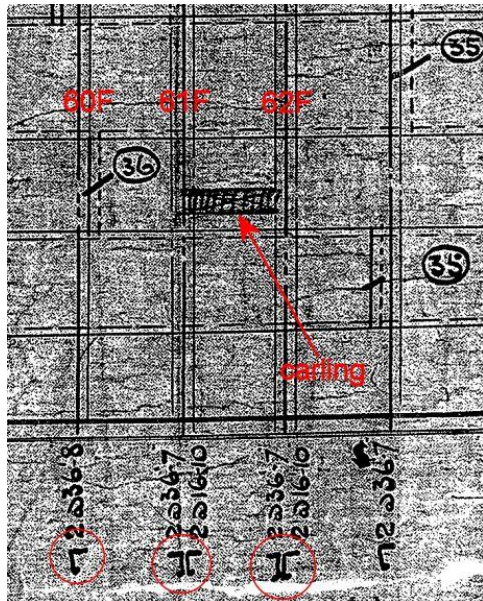

Figure 8

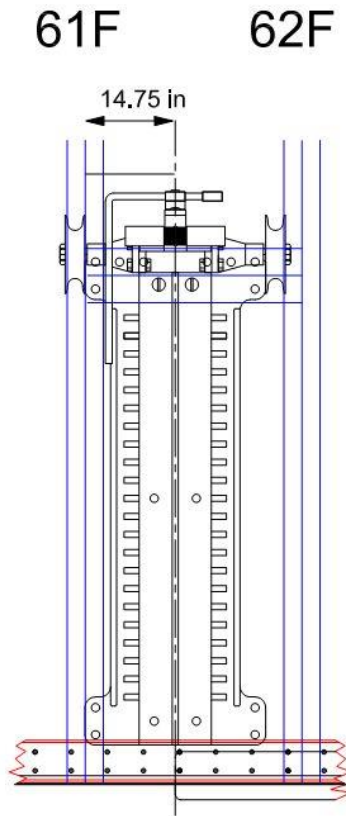

Figure 9

### Double Carling/Single Frame Davit Locations

There are two locations where single frame davits are mounted over double carlings. These davits are found at frames 35A and 28F. Because of the double carlings beneath these davits, they are positioned differently than the other two single frame davits positioned over single carlings. Figure 10 shows the positioning of the davit at 35A. It is shifted 6-11/64 in. forward of the deck beam at 35A. The single frame davit at 28F is shifted the same distance aft of the deck beam.

### Anomalies

There are two davit locations where the underlying beams can be characterized as anomalous. The two davit locations are at 57A and 68A. The beams near 57A and 68A are partial beams in that they only span from the outboard edge of the boat deck to the raised roof over the first



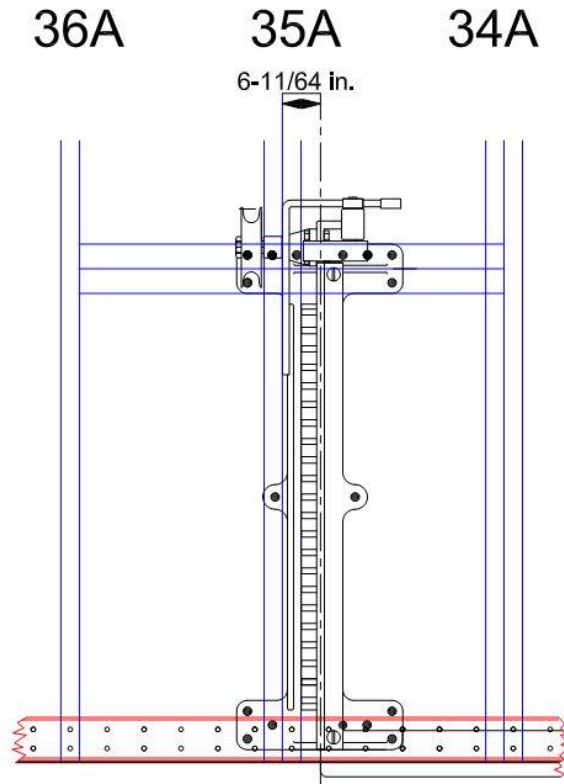

Figure 10

class smoke room. These two partial beams were each located 12 in. aft of hull frame locations 57A and 68A respectively to accommodate the framing of the smoke room. The davits at these two positions were shifted forward. The relation of the davit to the nearest deck beam was the same as at 39F which was previously explained. Both davits at these locations were shifted forward of their nearest hull frame locations by 6-51/64 in.

## A Rule

After considering the photo evidence for the davits at 39F, 79A and to a lesser extent at 61F there were quite a number of davits where we had no photos of the underside of the boat deck. It was therefore necessary to search the evidence to determine if there were a “rule” which could be followed to determine on which side of the central beam that the davit was shifted. What we found was that in almost every case there was one double bulb angle beam adjacent to the central beam. We determined that the davit was shifted in the direction of the adjacent double bulb angle beam. The only special situations are at frames 57A and 68A. These beams had double bulb angle beams on both sides of the central beam rather than one.

After attempting to shift the davits in both directions, it was found that the davits at both locations needed to be shifted forward. This was necessary to maintain the minimum necessary spacing of davits in order to accommodate the 30 ft. boats.

## Summary

In tabular form, here are the locations of the davits which are the same on both port and starboard sides:

<b>Davit Location</b>	<b>Direction shifted</b>	<b>Distance shifted</b>
72F	Forward	13 – 37/64 in.
61F	Forward	14 – 61/64 in.
50F	Forward	5 – 13/64 in.
39F	Aft	5 - 13/64 in.
28F	Aft	6 – 11/64 in.
35A	Forward	6 – 11/64 in.
46A	Aft	5 – 13/64 in.
57A	Aft	12 in. aft shift of beam + 5-13/64 in. = 6-51/64 in.
68A	Aft	12 in. aft shift of beam + 5-13/64 in. = 6-51/64 in.
79A	Aft	13 – 37/64 in.
<b>Davit Span</b>	<b>Distance</b>	<b>Boat Length</b>
72F-61F	32 ft. 10 - 5/8 in.	25 ft. wooden boat + 27.5 collapsible
61F-50F	33 ft. 9 – 3/4 in.	30 ft.
50F-39F	33 ft. 10 – 13/32 in.	30 ft.
39F-28F	33 ft. 0 – 31/32	30 ft.

<b>Davit Span</b>	<b>Distance</b>	<b>Boat Length</b>
35A-46A	33 ft. 11 – 3/8 in.	30 ft.
46A-57A	33 ft. 1-19/32 in.	30 ft.
57A-68A	33 ft.	30 ft.
68A-79A	33 ft. 6-25/32 in.	30 ft.

In summary, closer analysis of the evidence relating to the positions of the Welin boat davits shows that they were positioned to maximize their connections to underlying structural members. Some aspects of this analysis would relate to installation guidelines which would have been supplied by the Welin Co. This analysis has focused on the fore and aft positioning of the davits. More information would be necessary to determine the exact positions of the outboard ends of the davits in relation to the waterway. From photos it is possible to determine these locations fairly closely but it is not within the scope of this analysis.